



TMdrive™ -MVG2 Product Guide

Medium Voltage Multilevel IGBT Drive
Up to 19,500 kVA at 11 kV

metals

paper

cement

oil & gas

mining









utilities

rubber &
plastics

Global Products for Meeting Global Needs

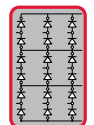
The TMdrive-MVG2 is a general-purpose, medium-voltage, variable-frequency AC drive for industrial power ratings up to 19.5 MVA, in the voltage range of 3.0/3.3 kV, 6.0/6.6 kV, and 10/11 kV. Featuring high-quality Japanese design and manufacture, the TMdrive-MVG2 works with existing or new induction or synchronous motors and meets users' basic system requirements as described below:

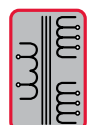

Design Feature	Customer Benefit
 <ul style="list-style-type: none"> No electrolytic capacitor in main circuit is used. Instead long-life film capacitors are used. 	<ul style="list-style-type: none"> Minimized maintenance and operating cost. Replacement of capacitors is not required within product life.
 <ul style="list-style-type: none"> Conservative design using 1700-volt IGBTs (Insulated Gate Bipolar Transistor) 	<ul style="list-style-type: none"> Highly reliable operation and expected 100,000 hour (12 years) drive MTBF, based on field of experience with the large global installed base of TMdrive-MVG family technology
 <ul style="list-style-type: none"> High energy efficiency approx. 97% 	<ul style="list-style-type: none"> Considerable energy savings, in particular on flow control applications
 <ul style="list-style-type: none"> Diode rectifier ensures power factor greater than 95% in the typical speed control range 	<ul style="list-style-type: none"> Capacitors are not required for power factor correction
 <ul style="list-style-type: none"> Multiple level drive output waveform to the motor (21 levels for the 6.6 kV inverter, line to line voltage, peak to peak) 	<ul style="list-style-type: none"> No derating of motor for voltage insulation or heating is required due to motor-friendly waveform
 <ul style="list-style-type: none"> Multi-pulse converter rectifier and phase shifted transformer: 3 kV Class: 18 pulse 10 kV Class: 48 pulse 6 kV Class: 30 pulse 11 kV Class: 54 pulse *Actual shift number depends on the rating of TMdrive-MVG2 	<ul style="list-style-type: none"> No harmonic filter required to provide lower harmonic distortion levels than IEEE-519-1992 guidelines
 <ul style="list-style-type: none"> Designed to keep running after utility supply-transient voltage dropouts – up to 300 msec. 	<ul style="list-style-type: none"> Uninterrupted service for critical loads
 <ul style="list-style-type: none"> Synchronous transfer to line option with no interruption to motor current (Additional equipment required) 	<ul style="list-style-type: none"> Allows control of multiple motors with one drive No motor current or torque transients when the motor transitions to the AC line
 <ul style="list-style-type: none"> Input isolation transformer included in the drive package 	<ul style="list-style-type: none"> Better protection of motor Simplified installation Lower cost installation Mitigation of harmonics on the primary side
 <ul style="list-style-type: none"> Direct drive voltage output level 	<ul style="list-style-type: none"> No output transformer required to match motor voltage, saving cost, mounting space, cabling, and energy Allows easy retrofit of existing motors

Bringing Reliable Control to a Wide Variety of Industries



Cement

The TMdrive-MVG2's compartmentalized design streamlines installation, commissioning, and maintenance of medium-voltage drives in the cement industry. With a Mean Time Between Failure (MTBF) exceeding 100,000 hours (12 years), the MVG is engineered to deliver rock-solid performance in virtually any application, making the TMdrive-MVG a best choice of many consultants, end users, and cement plant builders all over the world, including:

- Raw mill fans, bag house fans
- Preheater fans, coal mill fans
- Grinding mills
- Rotary kilns



Oil and Gas

In the Oil and Gas Industry, the MVG family of drives can be seamlessly integrated with the rest of your pump station control system with a choice of either 3.0/3.3, 6.0/6.6, 10, or 11 kV. They can be applied to existing motors and cabling, making them an excellent fit in modernization/retrofit applications, including:

- Oil pumps
- Gas compressors
- Fans



Mining

Accurate torque control is a key in controlling large conveyors. The MVG2's flux vector algorithm provides the accuracy and response for this demanding application.

Mining applications include:

- Raw material conveyor
- Grinding mills
- Pumps



Utilities/Power Generation

Traditional mechanical methods of controlling flow are inefficient and require considerable maintenance. In the Power Generation Utilities Industry, the MVG2 provides more reliable, accurate, and energy-efficient control of flow while eliminating the maintenance associated with dampers, vanes, or valves on:

- Induced and forced draft fans
- Primary and secondary air fans
- Boiler feed water pumps
- Condensate extraction pumps



Metals

The metal-making part of the steel plant uses large air flows and requires high power levels supplied by the MVG2 to operate:

- Water gas fans
- BOF ID fans
- Dust collection fans
- Blast furnace blower fans
- Utility pumps

A Look on the Inside

MV Drive Technology for medium voltage operation:

- Series connected inverter cell architecture uses 1700 V IGBT inverters for best reliability and high energy efficiency
- Diode bridge rectifiers yield high power factor operation
- Multi-winding transformer produces low input power distortion
- Modular drawable power cell design minimizes the time required for any maintenance activities

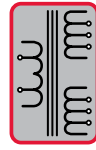

Input Transformer

The special input transformer has phase-shifted secondary windings to produce multi-pulse converter operation. This design exceeds the IEEE 519-1992 guidelines for input current distortion.

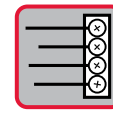

I/O Board

The I/O board supports encoder, 24 V dc I/O, 115 V ac inputs and analog I/O, standard. All I/O are terminated to a two-piece modular terminal block for ease of maintenance, located in right hand cabinet.

Main Power Input

Four voltage levels are available:

- **3.0-3.3 kV**, 3-phase, 50/60 Hz
- **6.0-6.6 kV**, 3-phase, 50/60 Hz
- **10 kV**, 3-phase, 50/60 Hz
- **11 kV**, 3-phase, 50/60 Hz

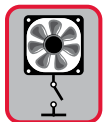
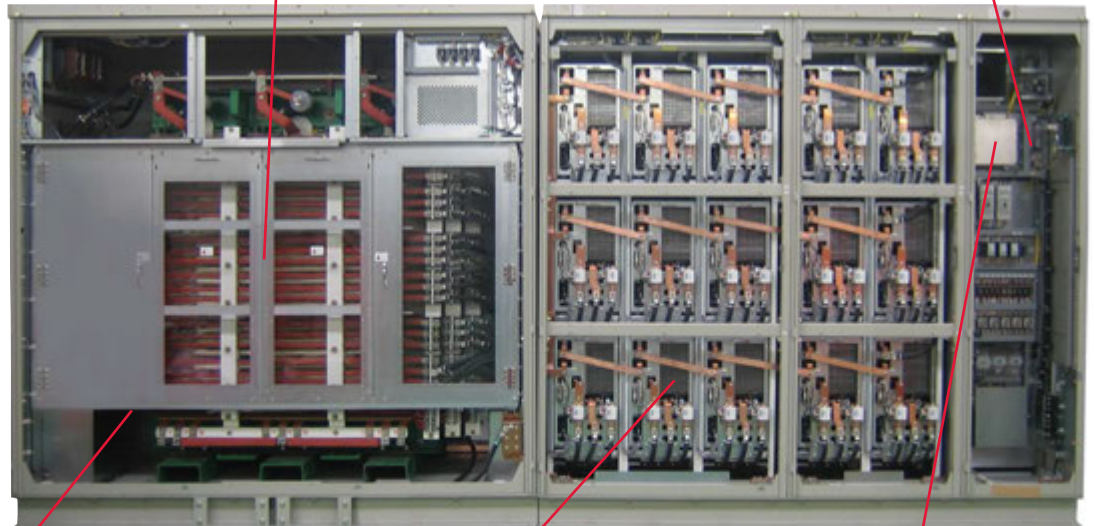

Air Cooling

Forced air cooling system with:

- Intake through cabinet doors
- Upward flow through inverter cells and transformer
- Exhaust at top of cabinet

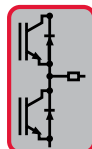

Cell Inverters

Example: Three banks of five series connected inverter cells, each containing:

- Diode bridge rectifier
- IGBT PWM inverter
- DC link long-life film capacitor
- Drawable module for ease of maintenance

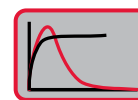

Control Functions

A single set of control boards feeds all inverter cells. The primary control board performs several functions:

- Speed and torque regulation
- Sequencing
- I/O mapping
- Diagnostic data gathering
- Provision for optional LAN interface



Slide-Out Inverter Modules

Each inverter cell contains a three-phase diode converter and a single-phase IGBT inverter, connected by a DC bus. One cell module is shown opposite, drawn out of the rack on a slide for service. All the modules are the same; refer to the diagram below. The mean time to repair the drive (MTTR) is 30 minutes or less.

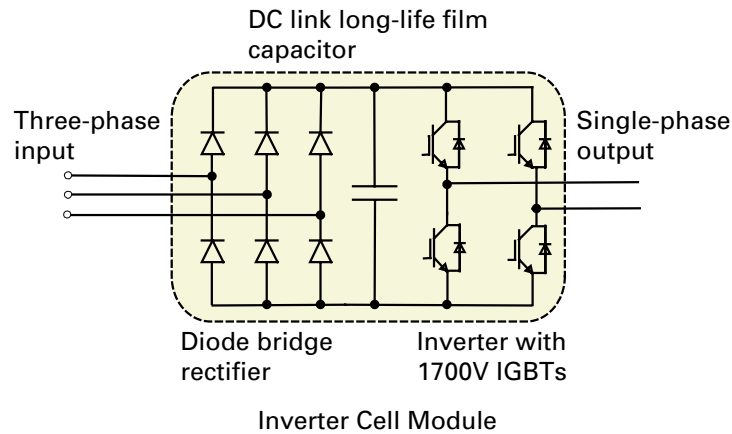

Inverter Cell Module Removed from Rack



Switching Devices

Switching devices are Insulated Gate Bipolar Transistors (IGBT).

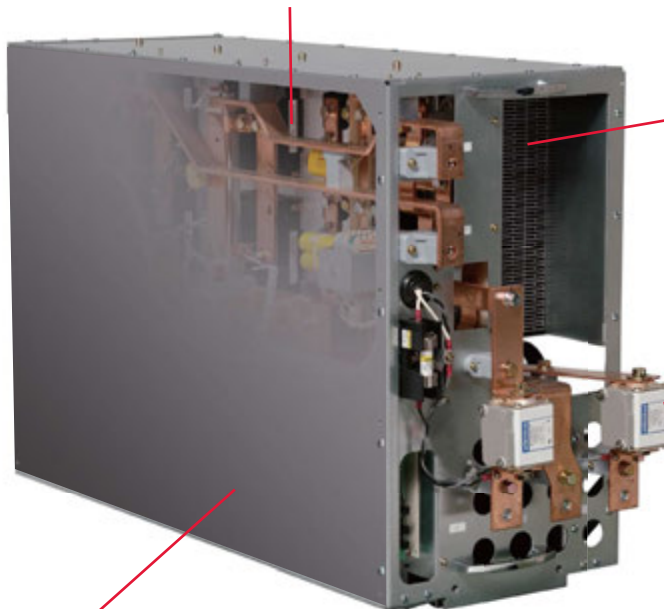

Cooling Heat Sink

Heat is transferred from the switching device heat sink to the cooling air.

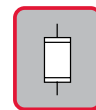

Input Fuse

Fused three-phase inputs to converter.

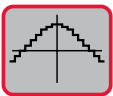

Control Board

- Board passes Pulse Width Modulated control signal to the gate drivers
- Gate driver circuit boards connect directly to IGBTs



Right Side View



DC Link long-life capacitors

No electrolytic capacitor in main circuit is used. Replacement of capacitors is not required within product life.

TMdrive-MVG2 Architecture

The TMdrive-MVG2 main circuit consists of an input transformer and single-phase PWM inverter cells. For 3 kV, three inverter cells are series connected to create an output with 7 output voltage levels.

TMdrive-MVG2 (3 kV class)

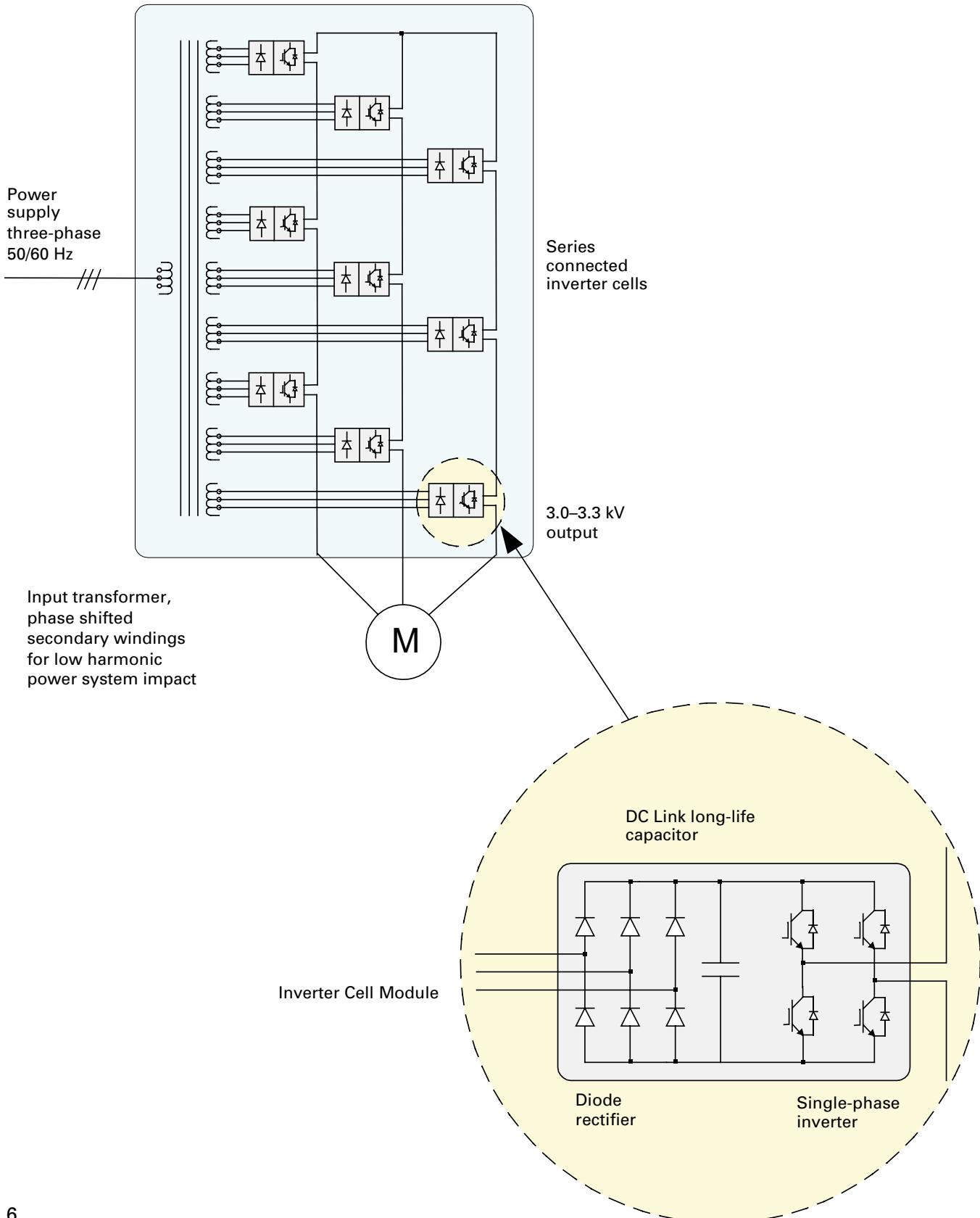

TMdrive-MVG2 Specifications

3.0/3.3 kV TMdrive-MVG2

Frame	Rated Output Current Amps *1		3.0 kV Output kVA	3.3 kV Output kVA	Approx. Motor Power HP @3.3 kV *2	Approx. Motor Power kW @3.3 kV *2	Panel Width mm (inch) *3	Panel Height with channel base mm (inch) *3	Panel Depth mm (inch) *3	Approx. Weight kg (lbs)
	125%	110%								
1	35	35	180	200	200	160	2100 (83)	2690 (106)	900 (36)	2900 (6393)
	53	53	270	300	335	250				
	70	70	360	400	340	320				
	74	—	380	420	460	340				
	—	77	400	440	480	355				
2	105	105	540	600	600	450	2200 (87)	2690 (106)	900 (36)	3850 (8488)
	140	140	720	800	880	650				
	147	—	760	840	930	685				
	—	154	800	880	960	710				
3	166	166	860	950	1000	750	2800 (111)	2860 (113)	1000 (40)	4700 (10362)
	192	192	1000	1100	1200	900				
	201	—	1035	1150	1250	935				
	—	210	1080	1200	1300	970				
4	227	227	1180	1300	1350	1000	3100 (122)	2860 (113)	1100 (44)	5800 (12787)
	263	263	1360	1500	1700	1250				
	276	—	1420	1580	1750	1300				
	—	289	1500	1650	1800	1340				
5	315	315	1630	1800	1900	1400	4000 (158)	2860 (113)	1100 (44)	6450 (14220)
	350	350	1810	2000	2100	1600	4100 (162)			6850 (15102)
	385	385	2000	2200	2400	1800				
6	420	420	2200	2400	2700	2000	4600 (182)	2860 (113)	1300 (52)	8300 (18299)
	525	525	2720	3000	3400	2500				
7	657	657	3400	3750	4300	3200	5400 (213)	2860 (113)	1700 (67)	10000
8	788	788	4090	4500	5250	3900	5700 (225)	3100 (122)	1800 (71)	12000
9	CF 997	CF 997	5180	5700	6750	5000	12800 (504)	2860 (113)	1300 (52)	21500 (47400)

Notes:

*1 1.25 PU or 1.1 PU overload, 60 sec rating; use Frame Amp rating for most acceptable match with motor

*2 Approximate capacity for 3.3 kV-based 4-pole induction motors

*3 The panel size may be modified according to its option

CF There are two banks; consult factory for dimensions and weights

Redundant cooling fans increase height

TMdrive-MVG2 Specifications

6.0/6.6 kV TMdrive-MVG2

Frame	Rated Output Current Amps *4		6.0 kV Output kVA	6.6 kV Output kVA	Approx. Motor Power HP @6.6 kV *5	Approx. Motor Power kW @6.6 kV *5	Panel Width mm (inch) *6	Panel Height with channel base mm (inch) *6	Panel Depth mm (inch) *6	Approx. Weight kg (lbs)
	125%	110%								
1	35	35	360	400	425	315	3200 (126)	2640 (104)	900 (36)	4320 (9524)
	53	53	540	600	610	450				
	70	70	720	800	875	650				
	74	—	760	840	920	680				
	—	77	800	880	960	710				
2	87	87	900	1000	1100	810	4000 (158)	2690 (106)	900 (36)	5550 (12236)
	105	105	1090	1200	1350	1000				
	122	122	1260	1400	1530	1130	4000 (158)	2690 (106)	1000 (40)	6250 (13779)
	140	140	1450	1600	1690	1250				
	147	—	1520	1680	1850	1360				
	—	154	1600	1760	1920	1420				
3	166	166	1720	1900	2160	1600	5000 (197)	2740 (108)	1000 (40)	7500 (16535)
	192	192	2000	2200	2430	1800				
	201	—	2010	2300	2450	1810				
	—	210	2160	2400	2620	1940				
4	227	227	2360	2600	3050	2250	5100 (201)	2760 (109)	1100 (44)	9100 (20062)
	262	262	2720	3000	3380	2500				
	276	—	2840	3150	3450	2540				
	—	289	3000	3300	3610	2670				
5	315	315	3270	3600	3780	2800	5900 (233)	2860 (113)	1200 (48)	10850 (23920)
	350	350	3630	4000	4260	3150				
	385	385	4000	4400	4800	3550				
6	420	420	4360	4800	5400	4000	5900 (233)	2860 (113)	1400 (56)	13050 (28770)
	473	473	4900	5400	6080	4500				
	525	525	5450	6000	6750	5000				
7	578	578	6000	—	6750 at 6.0 kV	5000 at 6.0 kV	7100 (280)	2910 (115)	1800 (71)	17350 (38250)
	626	626	6500	—	7560 at 6.0 kV	5600 at 6.0 kV				
	674	674	7000	—	8000 at 6.0 kV	6000 at 6.0 kV				
	730	730	7500	—	8780 at 6.0 kV	6500 at 6.0 kV				
	569	569	—	6500	6750	5000				
	613	613	—	7000	6750	5000				
	657	657	—	7500	7560	5600				
8	790	790	8200	—	8700 at 6.0 kV	6500 at 6.0 kV	10400 (410)	3130 (124)	1800 (71)	25000 (55115)
	867	867	9000	—	10000 at 6.0 kV	7500 at 6.0 kV				
	718	718	—	8200	9600	7100				
	788	788	—	9000	10000	7500				
9	CF 898	CF 898	9320	10260	11500	8500	16600 (654)	2860 (113)	1400 (56)	later
	CF 997	CF 997	10360	11400	13500	10000	16800 (662)			

Notes:

*4 1.25 PU or 1.1 PU overload, 60 sec rating; use Frame Amp rating for most acceptable match with motor

*5 Approximate capacity for 6.6 kV-based 4-pole induction motors

*6 The panel size may be modified according to its option

CF There are two banks; consult factory for dimensions and weights

Redundant cooling fans increase height

10/11 kV TMdrive-MVG2

Frame	Rated Output Current Amps *7		10 kV Output kVA	11 kV Output kVA	Approx. Motor Power HP @11 kV *8	Approx. Motor Power kW @11 kV *8	Panel Width mm (inch) @10 kV / 11 kV *9	Panel Height with channel base mm (inch) *9	Panel Depth mm (inch) *9	Approx. Weight kg (lbs) @10 kV / 11 kV
	125%	110%								
1	35	35	600	660	700	500	5300 (209) / 5600 (221)	3060 (121)	1400 (56)	8280 (18210) / 8620 (18960)
	53	53	900	990	1100	800				
	70	70	1200	1320	1400	1000				
	74	—	1280	1410	1420	1040				
	—	77	1330	1460	1420	1040				
2	87	87	1500	1650	1800	1350	6400 (252) / 6800 (268)	3060 (121)	1400 (56)	9590 (21143) / 10280 (22664)
	105	105	1800	2000	2200	1600				
	122	122	2100	2310	2500	1800				
	139	139	2400	2640	2760	2040				
	147	—	2540	2800	2920	2160				
3	—	154	2660	2930	3210	2375	6900 (272) / 7500 (296)	3110 (123)	1500 (60)	12800 (28219) / 13560 (29830)
	162	162	2800	3080	3400	2500				
	191	191	3300	3630	3780	2800				
	201	—	3480	3830	4000	2960				
4	—	210	3630	4000	4400	3250	7100 (280) / 7700 (304)	3110 (123)	1500 (60)	14960 (32982) / 15880 (34930)
	226	226	3900	4290	4500	3500				
	263	263	4500	5000	5200	3860				
	276	—	4780	5250	5500	4045				
5	—	289	5000	5500	5940	4400	11600 (457) / 12200 (480)	3110 (123)	1500 (60)	23630 (52096) / 24490 (53992)
	315	315	5400	6000	6500	4900				
	347	347	6000	6600	7200	5400				
6	386	386	6680	7350	7800	5800	11600 (457) / 12200 (480)	3110 (123)	1500 (60)	27470 (60561) / 28520 (62740)
	420	420	7200	8000	8700	6500				
	473	473	8100	9000	9800	7300				
7	525	525	9000	10000	10900	8000	13700 (540)	3110 (123)	1800 (71)	31050 (68454)
	578	578	10000	—	10900 at 10 kV	8000 at 10 kV				
	636	636	11000	—	11500 at 10 kV	8800 at 10 kV				
	730	730	12600	—	13500 at 10 kV	10000 at 10 kV				
	578	578	—	11000	11500	8800				
8	662	662	—	12600	13500	10000	14500 (571)	3130 (124)	1800 (71)	39350 (86752)
	786	786	13600	—	15300 at 10 kV	11700 at 10 kV				
	867	867	15000	—	17300 at 10 kV	12900 at 10 kV				
	714	714	—	13600	15300	11700				
9	788	788	—	15000	15500	11500	13900 (548) / 14500 (571)	3110 (123)	3800 (150)	62300 (137348) / 65240 (143830)
	CF 1024	CF 1024	17500	19500	21600	16000				

Notes:

*7 1.25 PU or 1.1 PU overload, 60 sec rating; use Frame Amp rating for most acceptable match with motor

*8 Approximate capacity for 11 kV-based 4-pole induction motors

*9 The panel size may be modified according to its option

CF There are two banks; consult factory for dimensions and weights

Redundant cooling fans increase height

TMdrive-MVG2 Specifications

Cabinet Minimum Maintenance Space

Voltage	Frame	Front Side Space	Rear Side Space	Ceiling Height
3.0/3.3kV class	1, 2	1600mm (63in)	20mm (0.8in)	3050mm
	3, 4, 5	1700mm (67in)	20mm (0.8in)	3100mm
	6, 9	1900mm (75in)	20mm (0.8in)	3100mm
	7	1900mm (75in)	600mm (24in)	3100mm
	8	2000mm (79in)	1000mm (39in)	3300mm
6.0/6.6kV class	1	1600mm (63in)	20mm (0.8in)	3050mm
	2	1600mm (63in)	20mm (0.8in)	3100mm
	3, 4, 5	1700mm (67in)	20mm (0.8in)	3100mm
	6, 9	1900mm (75in)	20mm (0.8in)	3100mm
	7	1900mm (75in)	600mm (24in)	3150mm
	8	2000mm (79in)	1000mm (39in)	3350mm
10/11kV class	1, 2	1800mm (71in)	600mm (24in)	3500mm
	3, 4	1900mm (75in)	600mm (24in)	3550mm
	5, 6, 7	2000mm (79in)	600mm (24in)	3550mm
	8	2000mm (79in)	1000mm (39in)	3550mm
	9	2000mm (79in)	860mm (34in)	3550mm

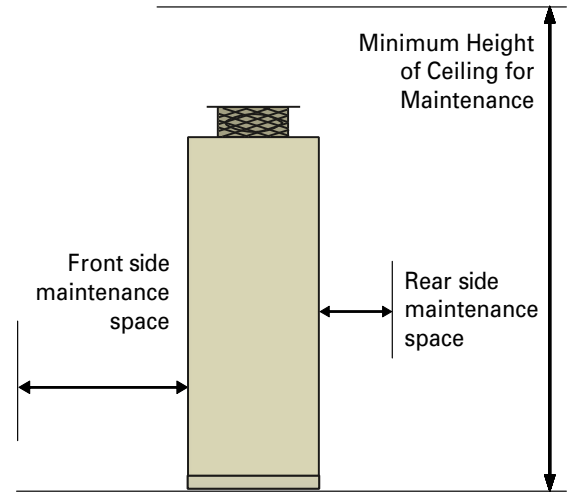

Notes

- $kVA_{Inverter} = \frac{\text{Power}_{Mtr Shaft}}{\text{Mtr PF} \times \text{Mtr Eff}}$
 $I_{Phase} = \frac{kVA_{Inverter}}{\sqrt{3} \times V_{Mtr Line to Line}} \times (1000) / (1.732) \times$
 - Mtr PF – 0.87, Mtr Eff = 0.94, ambient temperature is 32°F–104°F (0°C–40°C).
 - Ratings based on a variable torque load (industrial fans and pumps).
 - Altitude above sea level is 0–3300 ft (0–1000 m).
 - Dimensions to top of cooling fans are for the nonredundant type fans.
- An optional bypass circuit can be separately mounted.
- Redundant cooling fans are available as an option (except for 7 & 8 Frame of 6/6.6/10/11kV); overall height increases.
- No rear access is required except for 10/11 kV Class drives.
- Incoming power cabling and motor cabling are bottom entry; top entry is an option.
- Air is pulled in through the filters in the cabinet doors and vented out the top.
- Available options include motor cooling fans and control, cabinet space heater, bypass power/control and dv/dt filter, HV input, sync motor control, smooth transfer to and from utility.
- For conservative sizing of cooling equipment, heat rejection is 3 kW/100 kVA (3 kW/100 hp) of output power.
- The panels are fixed to the channel bases and shipped.

Features of the TMdrive-MVG2

A Clean Wave Inverter

Using the multiple winding input transformer, the TMdrive-MVG2 has multi-pulse rectification and more than meets the requirements of IEEE-519 (1992). This reduces the harmonic current distortion on the power source and protects the other equipment in the plant. The harmonic current content measured in an actual load test is compared with IEEE-519 in the chart opposite.

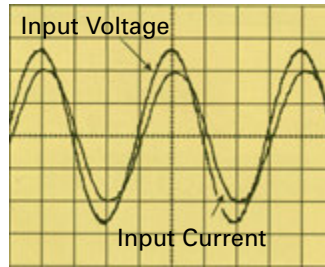

Typical Input Wave Forms

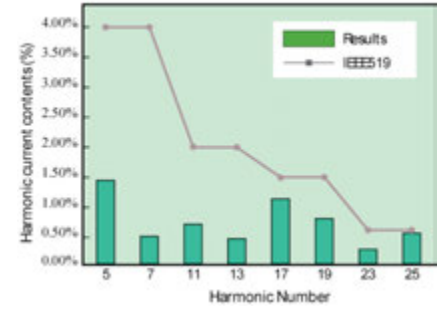

Typical Harmonic Contents of Input Current for 18-pulse System

A Clean Output Wave

As a result of the multilevel PWM control, the output waveform is close to a sine wave, and the heat loss caused by harmonics is negligible. In addition, harmonic currents in the motor are minimized so there is very little torque ripple on the output shaft.

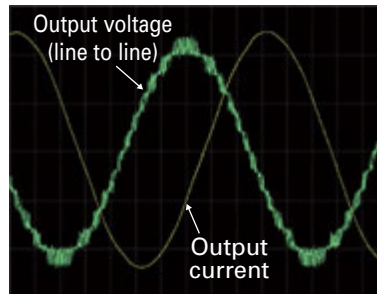

Current and Voltage Output Waveforms for 3.3 kV Drive

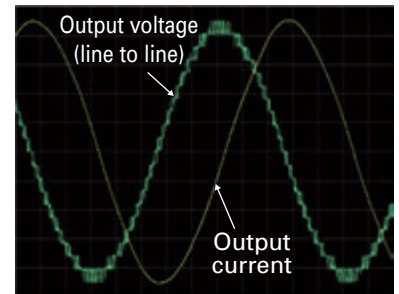

Current and Voltage Output Waveforms for 6.6 kV Drive

A Higher Efficiency than Conventional Drives

Actual factory load tests show the drive efficiency is approximately 97% (design value). This high efficiency is a result of:

- A smaller number of switching semiconductors by using 1700 V IGBTs
- Lower switching frequencies using multilevel PWM control reduce the switching loss of each IGBT
- Direct connection of MV motor without an output transformer

Example: 6.6 kV drive at 6,000 kVA and 50 Hz			
Current	100%	75%	50%
Efficiency	97.1%	97.2%	97.5%
Except for the consumption of control power and auxiliary power.			

A High Input Power Factor

Each inverter cell has a diode bridge rectifier. As a result, the input power factor is above 95% over the entire normal operating speed range, even when driving a multiple-pole induction motor of low power factor. With this high power factor, no power factor correction capacitor is required.

Power Factor in <i>Italic</i> , Expressed in % * = Interpolated Value		Percent of Top Speed vs % PF Lagging				
		20	40	60	80	100
Percent of Full Load	20	94.7%	95.5%	*95.6%	*95.7%	95.8%
	40		96.6%	96.7%	*96.4%	96.2%
	60			96.3%	96.4%	96.4%
	80				96.1%	96.8%
	100					97.1%
Examples of measured power factor						

Common Control Boards to Reduce Cost of Ownership

Standard Connections

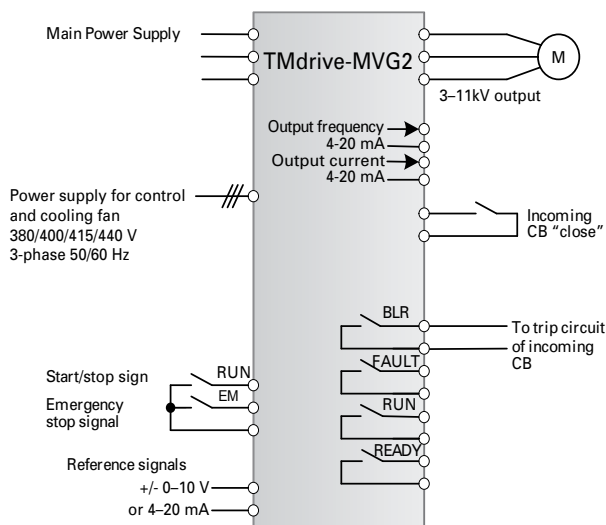

Control I/O

Control Area	Specifications
Analog Inputs	(2) ± 10 V or 4–20 mA, configurable, differential
Analog Outputs	(4) ± 10 V, 12-bit, configurable, 10 mA max
Digital Inputs	(2) 24–110 Vdc or 48–120 Vac; (6) 24 Vdc, configurable
Digital Outputs	(6) 24 Vdc open collector 50 mA
Speed Feedback Encoder Input	High-resolution tach, 10 kHz, 5 or 15 Vdc diff. input, A Quad B, with marker
LAN Interface Options	Profibus-DP, ISBus, DeviceNet™, Modbus RTU, TC-net, CC-Link
Motor Temperature Sensor	High-resolution torque motor temperature feedback: 1 k Ohm platinum resistor or 100 Ohm platinum RTD (uses analog input with signal conditioner)

Display and Diagnostics

	Specifications
PC Configuration	Control System Drive Navigator for configuration, local and remote monitoring, animated block diagrams, dynamic live and capture buffer based trending, fault diagnostics, commissioning wizard, and regulator tune-up wizards. Ethernet 10 Mbps point to point or multi-drop, each drive has its own IP address
Keypad and Display	Backlit LCD, animated displays <ul style="list-style-type: none"> Parameter editing Four configurable bar graphs Drive control
Instrumentation Interface	Two analog outputs dedicated to motor current feedback, plus five analog outputs that can be mapped to variables for external data logging and analysis

Additional Specifications

Power System Input and Harmonic Data

- Voltage: up to 11 kV, 3-phase, +10%/–10%
- Tolerates power dips up to 25% without tripping, complete power loss ride through of 300 msec
- 125% Overload (OL) for 60 seconds; other OL ratings available
- Frequency: 50 Hz or 60 Hz, $\pm 5\%$
- Power factor (PF): 0.95 lag
- True PF: greater than 0.95 lag over 40–100% speed range
- Exceeds the IEEE 519-1992 standard for harmonics, without filters
- Bottom cable entry

Converter Type

- AC-fed multi-pulse diode using phase shifted transformer

Transformer

- Dry type transformer
- Air cooled type
- Multi LV windings

Inverter

- Multilevel inverter cells:
 - three in series for 3.3 kV inverter
 - five or six in series for 6.6 kV inverter
 - eight or ten in series for 10 kV inverter
 - nine or ten in series for 11 kV inverter
- 0–72 Hz
- Up to 120 Hz, option for 3.0/3.3 kV and 6.0/6.6 kV
- For 10/11 kV, maximum frequency 72 Hz
- Multilevel output for motor-friendly waveform

Applicable Standards

- IEC61800-4, JIS, JEC, JEM

Control

- Nonvolatile memory for parameters and fault data
- Vector control with or without speed feedback, or Volts/Hz
- Designed to keep running after utility supply transient voltage dropouts of 300 ms
- Synchronous transfer to line option
- Synchronous motor control (option)

Vector Control Accuracy and Response

- Maximum speed regulator response: 20 rad/sec
- Speed regulation without speed sensor $\pm 0.5\%$
- Maximum torque current response: 500 rad/sec
- Torque accuracy: $\pm 3\%$ with temp sensor, $\pm 10\%$ without

Major Protective Functions

- Inverter overcurrent, overvoltage
- Low or loss of system voltage
- Motor ground fault
- Motor overload
- Cooling fan abnormal
- Over-temperature
- CPU error

Mechanical Specifications

Operating Environment and Needs

- Temperature: 0° to +40°C
- Humidity: 85% maximum, noncondensing
- Altitude: Up to 1000 m (3300 ft) above sea level:
- Fan: 380/400/440 Vac, 3 phase, 50 Hz or 60 Hz

Cooling

- Air-cooled with fans on top

Sound

- Approx. 76-79 dB(A)@50Hz, at 3.1ft (1 m) from enclosure
- Approx. 80-83 dB(A)@60Hz, at 3.1ft (1 m) from enclosure

Enclosure

- IP30 except for fan openings (IEC 60529), NEMA1 gasketed equivalent
- Color: Munsell 5Y7/1 (Option: ANSI 61 gray, RAL7032 etc.)

Drive/Motor Monitoring

Operator Keypad

High Function Display

- LCD backlight gives great visibility and long life
- Bar graphs, icons, menus, and digital values combine to provide concise status information, often eliminating the need for traditional analog meters



RJ-45 Ethernet port is used for the local Drive Navigator (toolbox) connection

Instrumentation Interface

- Two analog outputs are dedicated to motor current feedback
- Five analog outputs are mapped to variables for external data logging and analysis

Easy-to-understand navigation buttons allow quick access to information without resorting to a PC-based tool

Switch to local mode to operate the equipment from the keypad

Interlock button disables the drive

Display Group	Icon	Status Indication
Heartbeat		Communication OK
		Communication error
Control State		Local mode
		Remote mode
		Test mode
Fault State	Blank	Drive OK
		Alarm state
		Trip fault
Drive Indication		Forward rotation
		Reverse rotation
Motion		Drive not ready
		Drive not running
		Drive running forward
		Drive running reverse

Multi-language Keypad – Optional Operator Interface (below)



The optional multi-language keypad is a touch-panel display with the same functionality as the standard keypad. Chinese version is shown here. The main features are:

- 5.7 inch (145 mm) LCD color display
- Choice of languages, touch selection:
 - English
 - Japanese
 - Chinese
 - Russian
 - Spanish
 - French
 - Portuguese
 - Italian
 - Korean
 - Polish
- The Ethernet communication with the drive, analog check pins, interlock button, and status LEDs are mounted separately

Drive Navigator — Configuration, Monitoring & Analysis

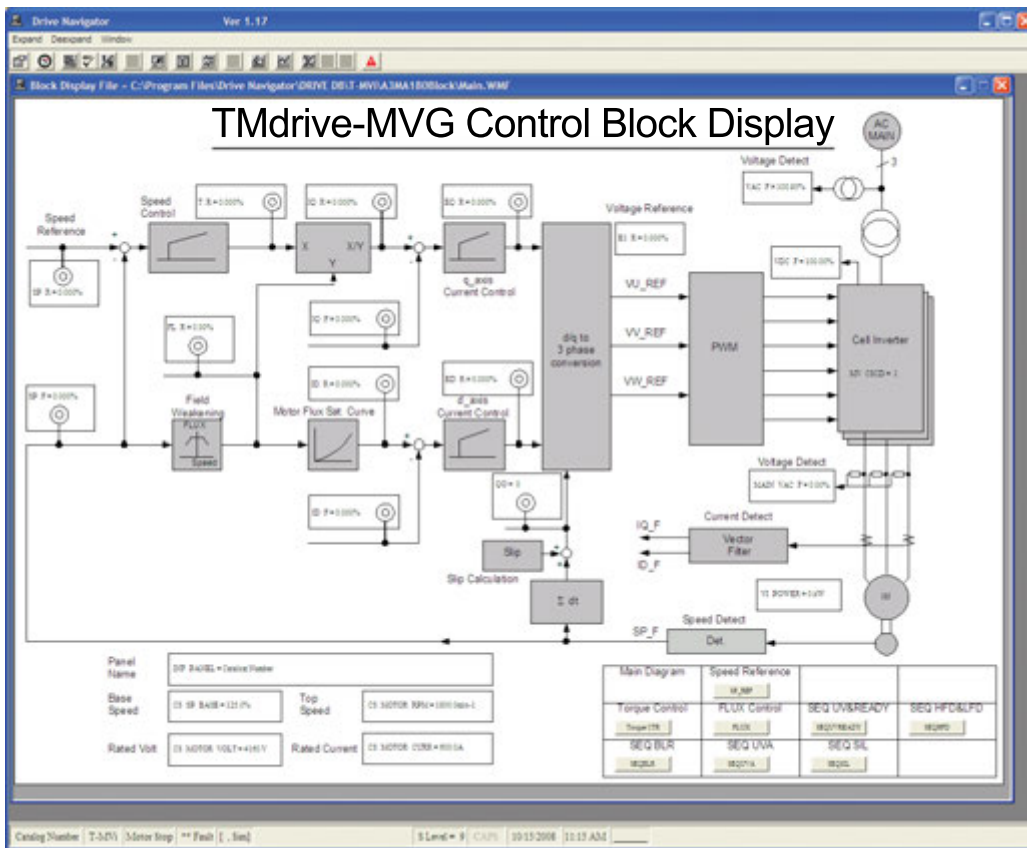

Real-Time Drive Block Diagram

Drive Configuration

All the TMdrive family of drives are configured and commissioned with the Windows-based Drive Navigator. Wizards intelligently guide the user through the required steps. Included are live block diagrams, highly integrated help, and high-performance diagnostics. Several sets of drives can be maintained using Ethernet communication. The control block display opposite shows the main drive control functions together with real-time values of the important variables. Available Navigator functions include:

Parameter (Set Point) Control

- Loading and saving a parameter file
- Changing a parameter
- Comparing parameter files

Support Functions

- Control block display
- Snapshot function
- Step response test
- Response wave display

Drive Troubleshooting

This screen displays a drive first fault and shows selected trend displays to assist in determining the cause. The fastest trend displays four variables sampled at a rate of 417 microseconds. The other two slower trends are sampled at 1 millisecond and 100 milliseconds.

Available Troubleshooting Functions:

- First fault display
- Operation preparation display
- Fault trace back
- Trouble records
- Fault history display
- Online manual

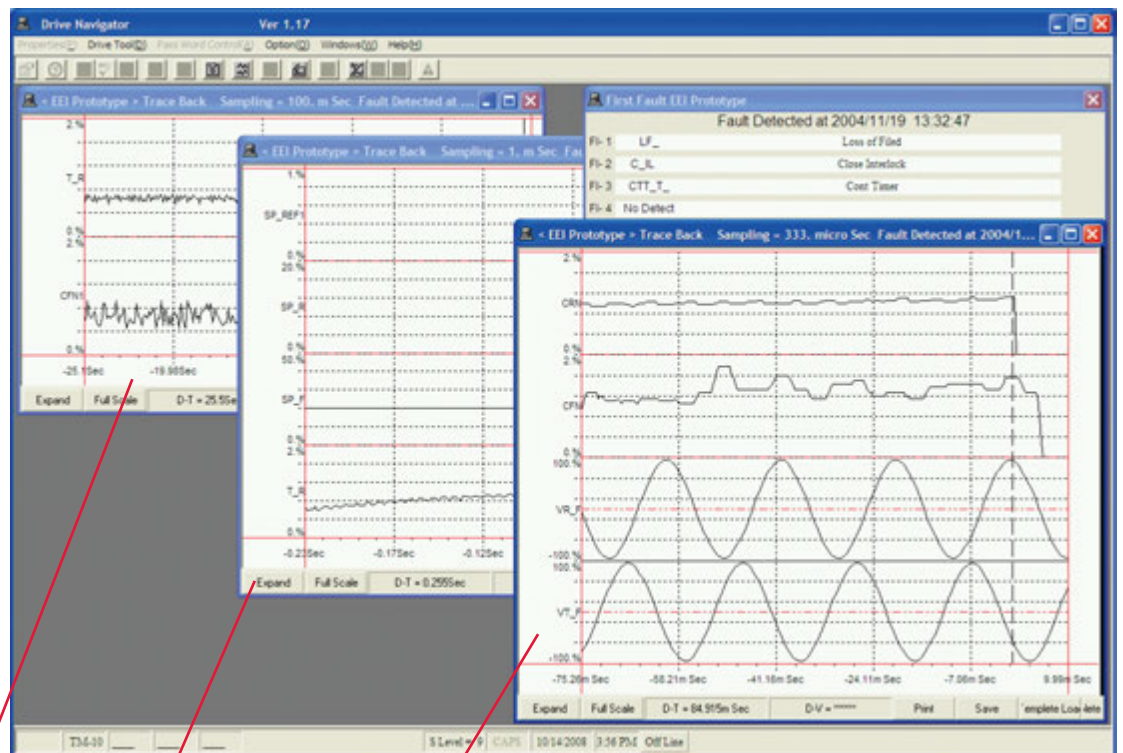

100 msec. sampling

1 msec. sampling

417 micro sec. sampling

Energy Savings Payback Calculations

Replacing a mechanical speed control device with an adjustable speed drive usually produces large energy savings plus a reduction in maintenance costs. This appendix outlines how the energy savings can be calculated as follows:

1. Calculate the cost of energy used by the electric drive speed control system.
2. Calculate the cost of energy used by the mechanical speed control system.

The difference is the **energy cost savings**. Typical power consumption curves for pumps and fans are shown below.

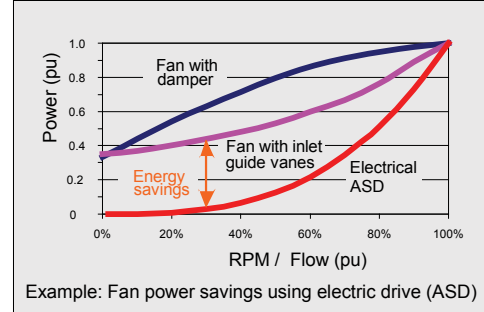
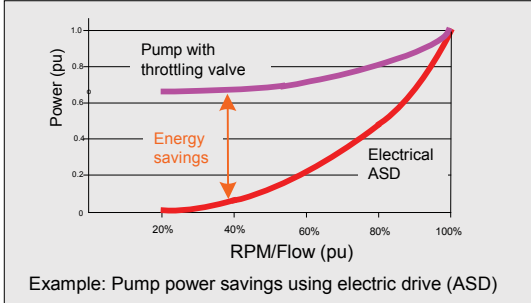

Below is an example of the energy cost calculation for a pump driven by a motor and electric drive. The calculation for the mechanical system is similar and is described on the next page. Since energy consumption varies with speed and flow, you need the load profile table which shows the number of hours running at the various flows. Refer to the example below.

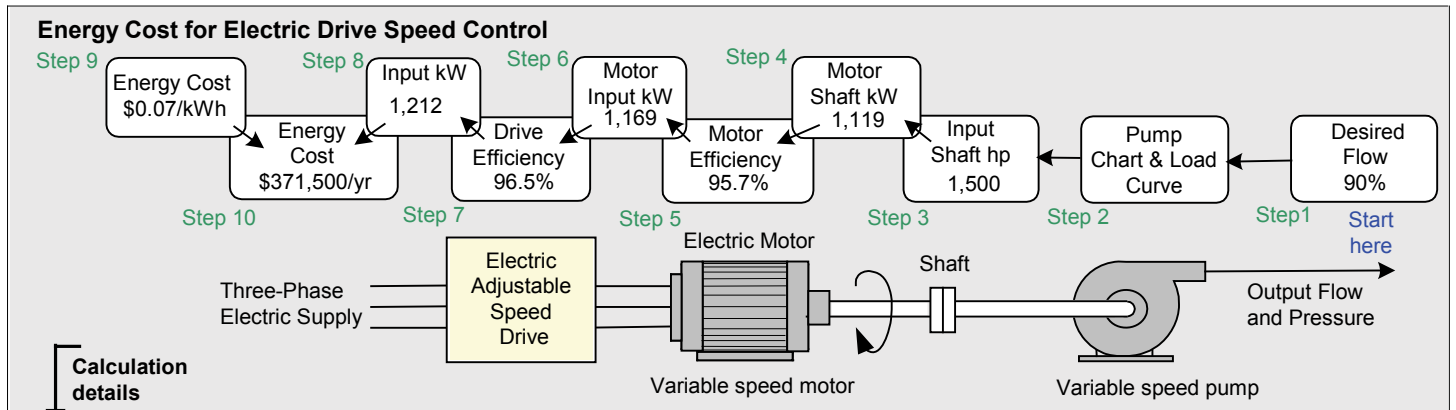

Step	Calculation details	Pump Performance Chart & Load Curve	Notes											
Step 1	Select the desired pump output flow, for example 90%, and number of hours/day at this flow, for example 12.		Overlay the load pressure-flow curve on the pump chart and find the pump input shaft horsepower at the 90% flow (point B). You need the load profile. See example below. Pump input power at N2 rpm = 1,500 hp at point B, 90% flow.											
Step 2	Obtain the variable speed pump performance chart and the load pressure-flow curve, which is the flow resistance of the process being fed.		<table border="1"> <caption>Daily Load Profile (example)</caption> <tr> <td>Operation Hours/day</td> <td>5</td> <td>12</td> <td>5</td> <td>1</td> <td>1</td> </tr> <tr> <td>Percent Flow</td> <td>100%</td> <td>90%</td> <td>80%</td> <td>70%</td> <td>60%</td> </tr> </table>	Operation Hours/day	5	12	5	1	1	Percent Flow	100%	90%	80%	70%
Operation Hours/day	5	12	5	1	1									
Percent Flow	100%	90%	80%	70%	60%									
Step 3	Find the pump input power.													
Step 4	Convert the input shaft horsepower to shaft kW	Conversion: Horsepower x 0.746 = kW	Input shaft kW = 1,500 hp x 0.746 = 1,119 kW											
Step 5	Obtain the electric motor efficiency	Example: Induction motor efficiency 95.7% from manufacturer's data sheets (find at each RPM)	Motor input power = 1,119 kW/0.957 Efficiency = 1,169 kW											
Step 6	Obtain the adjustable speed drive efficiency	Example: Drive efficiency 96.5% from manufacturer's data sheets (find at each RPM)	Drive input power = 1,169 kW/0.965 Efficiency = 1,212 kW											
Step 7	Obtain the electric power cost	Example: Energy cost = \$0.07/kWh. Calculate cost for the hours at this flow from load profile; in this example it is 12 hours/day.	Energy cost = 1,212 kW x 0.07\$/kWh x 12 hrs/day x 365 days per year = \$371,500 per year. (Repeat calculation for other flows in load profile and total).											

TMEIC Drives Offer Complete Coverage

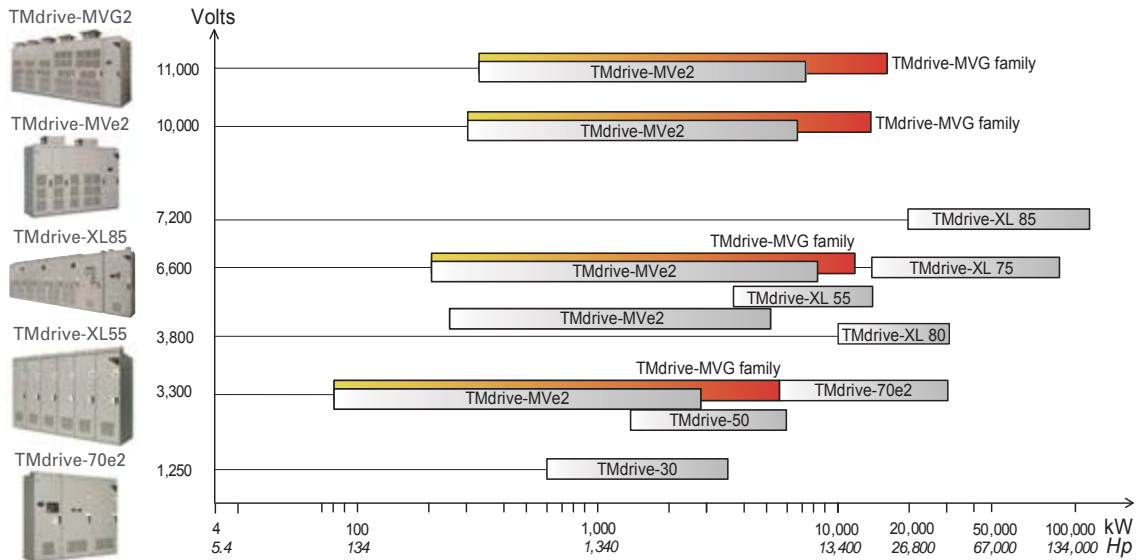

Global Office Locations :

Toshiba Mitsubishi-Electric Industrial Systems Corporation TOKYO SQUARE GARDEN,
3-1-1 Kyobashi, Chuo-ku, Tokyo 104-0031, Japan
Phone: +81-3-3277-4510 Fax: +81-3-3277-4566 Web: www.tmeic.com/

TOSHIBA INTERNATIONAL CORPORATION PTY LTD
11a Gibbon Road, Winston Hills
NSW 2153 AUSTRALIA
Tel: +61-2-8867 6200 Fax: +61-2-9624 7104
Email: hvm@tic.toshiba.com.au

To users of our inverters:

PRECAUTIONS

- Read the entire "Instruction Manual" carefully for important information about safety, handling, installation, operation, maintenance, and parts replacements.
- When using our inverters for equipment such as nuclear power control equipment, aviation and space flight control equipment, traffic equipment, and safety equipment, and there is a risk that any failure or malfunction of the inverter could directly endanger human life or cause injury, please contact our headquarters, branch, or office printed on the front and back covers of this brochure. Such applications must be studied carefully.
- When using our inverters for critical equipment, even though the inverters are manufactured under strict quality control, always fit your equipment with safety devices to prevent serious accident or loss should the inverter fail (such as failure to issue an inverter trouble signal).

TMdrive is a trademark of Toshiba Mitsubishi-Electric Industrial Systems Corporation.

All other products mentioned are registered trademarks and/or trademarks of their respective companies.

All specifications in this document are subject to change without notice. The above brochure is provided free of charge and without obligation to the reader or to TMEIC, and is for informational purposes only. TMEIC does not accept, nor imply, the acceptance of any liability with regard to the use of the information provided. TMEIC provides the information included herein as is and without warranty of any kind, express or implied, including but not limited to any implied statutory warranty of merchantability or fitness for particular purposes. The brochure is not an implied or express contract.